

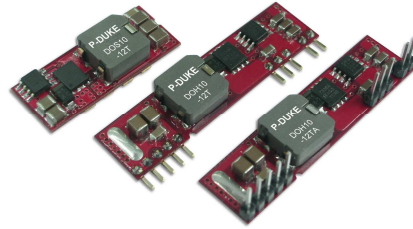

**POWER MATE
TECHNOLOGY CO., LTD.**

**DOS10-12T
DOH10-12T**
DC-DC CONVERTER



UP TO 10 Amps



FEATURES

- NO MINIMUM LOAD REQUIRED
- SMALL SIZE AND LOW PROFILE :
SMD TYPE:1.30 X 0.53 X 0.30 INCH , SIP TYPE:2.00 X 0.50 X 0.28 INCH
- SMD PACKAGE QUALIFIED FOR LEADFREE REFLOW SOLDER PROCESS ACCORDING IPC J-STD-020D
- UL60950-1, EN60950-1, & IEC60950-1 SAFETY APPROVALS
- CE MARKED
- COMPLIANT TO RoHS II & REACH

APPLICATIONS

- WIRELESS NETWORK
- TELECOM/DATACOM
- INDUSTRY CONTROL SYSTEM
- DISTRIBUTED POWER ARCHITECTURES
- SEMICONDUCTOR EQUIPMENT
- MICROPROCESSOR POWER APPLICATIONS

REMOTE CONTROL

UVP

OCP

SCP

TECHNICAL SPECIFICATION All specifications are typical at nominal input, full load and 25°C otherwise noted

Model Number	Input Range VDC	Output Voltage VDC	Output Current @Full Load A	Input Current Vin(nom) @ No Load		Efficiency Vin(nom),3.3VDC @Full Load %	Maximum Capacitor Load (1)	
				0.75VDC / 5.0VDC	mA		ESR ≥ 1mΩ / ESR ≥ 10mΩ	μF
DOS10-12T	Vout(set) ≤ 3.63	0.75 ~ 5	10	40 / 100	93	1000 / 5000		
DOS10-12T-P	Vin = 8.3 ~ 14							
DOH10-12T	Vout(set) > 3.63							
DOH10-12T-P	Vin = 8.3 ~ 13.2							

PART NUMBER STRUCTURE

DOS10 - 12 T - P

Series Name	Input Voltage (VDC)	Package	Remote Control Option
DOS10: SMD TYPE DOH10: SIP TYPE	12: 8.3~14	SMD TYPE T:No Assembly SIP TYPE T:Vertical Mounting SIP TA:Horizontal Mounting SIP	□: Negative Logic P: Positive Logic

INPUT SPECIFICATIONS

Parameter	Conditions	Min.	Typ.	Max.	Unit
Operating input voltage range	Vout(set) ≤ 3.63VDC	8.3	12	14	VDC
	Vout(set) > 3.63VDC	8.3	12	13.2	
Maximum input current	Vin=8.3 to 14VDC, Io=Io(max.)		7		A
Input reflected ripple current	5~20MHz, 1μH source impedance		20		mAp-p
Start-up voltage			7.9		VDC
Shutdown voltage			7.8		VDC
Input filter (2)					Capacitor type

OUTPUT SPECIFICATIONS

Parameter	Conditions	Min.	Typ.	Max.	Unit
Voltage accuracy					% of Vout(set)
Line regulation	Vin=Vin(min.) to Vin(max.) at Full Load	-2.0		+2.0	%
Load regulation	No Load to Full Load	-0.3		+0.3	%
Voltage adjustability (3)		-0.4		+0.4	%
Ripple and noise	Measured by 20MHz bandwidth, With a 1μF MLCC & a 10μF T/C	0.7525		5	VDC
				30	mVrms
				75	mVp-p
Temperature coefficient		-0.4		+0.4	%/°C
Dynamic load response	With a 1μF MLCC & a 10μF T/C ΔIo/Δt=2.5A/μs, Vin(nom) Peak deviation 50% load step change Setting time(Vout<10%peak deviation)		200		mV
			25		μs
Dynamic load response	With 2pcs of 150μF polymer capacitors ΔIo/Δt=2.5A/μs, Vin(nom) Peak deviation 50% load step change Setting time(Vout<10%peak deviation)		100		mV
			25		μs
Over load protection	% of Iout rated		200		%
Short circuit protection			Continuous, automatic recovery		
Output voltage overshoot-startup	Vin= Vin(min.) to Vin(max.) at Full Load		1.0		%

GENERAL SPECIFICATIONS

Parameter	Conditions	Min.	Typ.	Max.	Unit
Isolation voltage					None
Switching frequency		270	300	330	kHz
Safety approvals					UL60950-1 EN60950-1 IEC60950-1
Weight					6.0g (0.21oz)
MTBF	MIL-HDBK-217F, Full load				3.355 x 10 ⁶ hrs

ENVIRONMENTAL SPECIFICATIONS

Parameter	Conditions	Min.	Typ.	Max.	Unit
Operating ambient temperature	With derating	-40		+85	°C
Over temperature protection			125		°C
Storage temperature range		-55		+125	°C
Thermal shock					MIL-STD-810F
Vibration					MIL-STD-810F
Relative humidity(non-condensing)					5% to 95% RH
Lead-free reflow solder process					IPC J-STD-020D
Moisture sensitivity level(MSL)					IPC J-STD-033B Level 2a

FEATURE SPECIFICATIONS

Parameter	Conditions	Min.	Typ.	Max.	Unit
Remote ON/OFF (4)	Referred to -Vin pin Negative logic DC-DC ON (Standard) DC-DC OFF Positive logic DC-DC ON (Option) DC-DC OFF Input current of Ctrl pin Remote off input current				Open or 0 ~ 0.3VDC 2.5VDC ~ Vin(max.) Open or (Vin-4) ~ Vin(max.) 0 ~ 0.3VDC
		0.01		1.0	mA
			2.0		mA
Remote sense range				0.5	VDC
Rise time	Time for Vout to rise from 10% to 90%of Vout(set)			6	ms
Turn-on delay time	Case 1 (5), Case 2 (6)		3		ms

Note:

1. Test by minimum input and constant resistive load.
2. It's necessary to equip the external input capacitors at the input of the module. The capacitors should connect as close as possible to the input terminals that ensuring module stability. The external C_{in} is 4pcs of 47 μ F ceramic capacitors at least.
3. Output voltage programmable from 0.7525V to 5V by connecting a single resistor (shown as Trim Table) between the Trim and GND pins of the module. To calculate the value of the resistor Rtrim for a particular output voltage Vout, use the following equation:

$$R_{trim} = \left[\frac{10500}{V_{out} - 0.7525} - 1000 \right] \Omega$$

Trim Figure

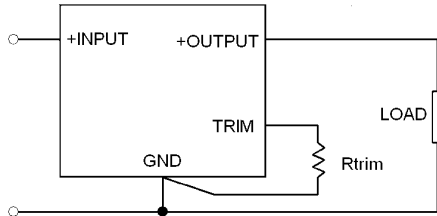

Trim Table

Vout(set) (VDC)	Rtrim (k Ω)
0.7525	Open
1.2	22.46
1.5	13.05
1.8	9.024
2.5	5.009
3.3	3.122
5	1.472

4. Positive logic:ON/OFF is open collector/drain logic input
Negative logic:ON/OFF pin is open collector/drain logic input with external pull –up resistor
5. Case 1: ON/OFF input is set to logic low (module on) and then input power is applied (delay from instant at which $V_{in}=V_{in(min.)}$) until $V_{out}=10\%$ of $V_{out(set)}$)
6. Case 2:Input power is applied for at least one second and then the ON/OFF input is set to logic low (delay form instant at which $V_{on/off}=0.3VDC$ until $V_{out}=10\%$ of $V_{out(set)}$)

CAUTION: This power module is not internally fused. An input line fuse must always be used.

CHARACTERISTIC CURVE

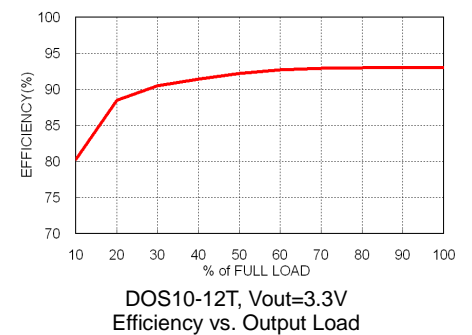
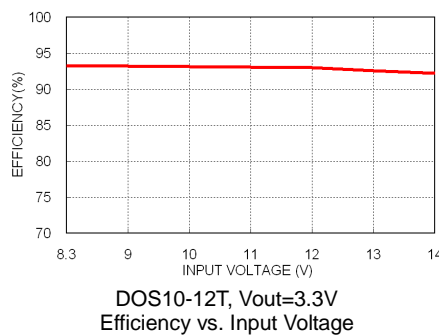
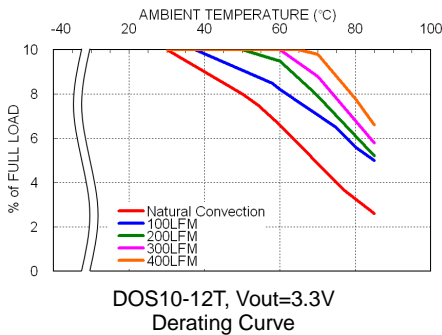

MECHANICAL DRAWING

DOS10-12T

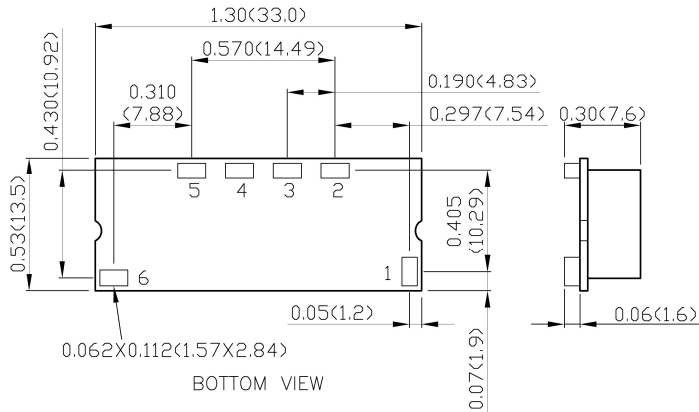

PIN CONNECTION

PIN	DEFINE
1	Ctrl
2	+Sense
3	Trim
4	+Vout
5	GND
6	+Vin

DOH10-12T

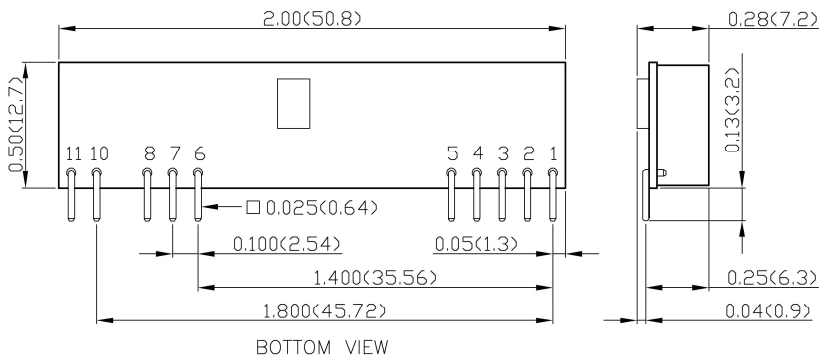

PIN CONNECTION

PIN	DEFINE
1	+Vout
2	+Vout
3	+Sense
4	+Vout
5	GND
6	GND
7	+Vin
8	+Vin
10	Trim
11	Ctrl

DOH10-12TA

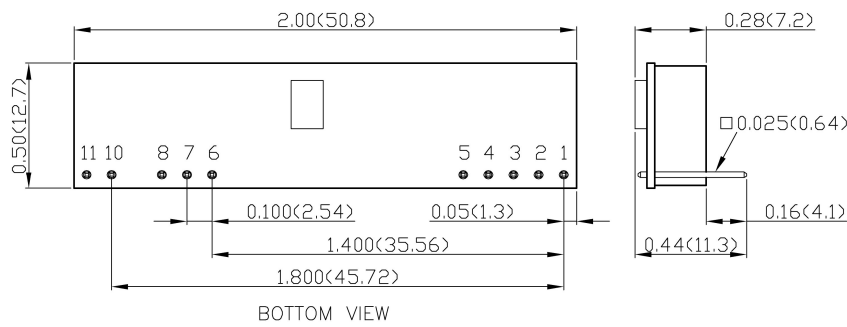

PIN CONNECTION

PIN	DEFINE
1	+Vout
2	+Vout
3	+Sense
4	+Vout
5	GND
6	GND
7	+Vin
8	+Vin
10	Trim
11	Ctrl

1. All dimensions in inch (mm)
2. Tolerance :x.xx±0.02 (x.x±0.5)
x.xxx±0.01 (x.xx±0.25)
3. Pin pitch tolerance ±0.01 (0.25)
4. Pin dimension tolerance ±0.004(0.1)